

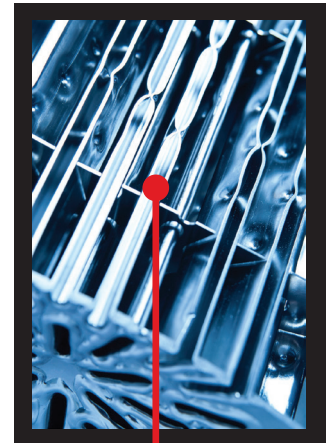

Advanced Heating
& Hot Water Systems

Elite FT

High Efficiency Fire Tube Heating Boiler

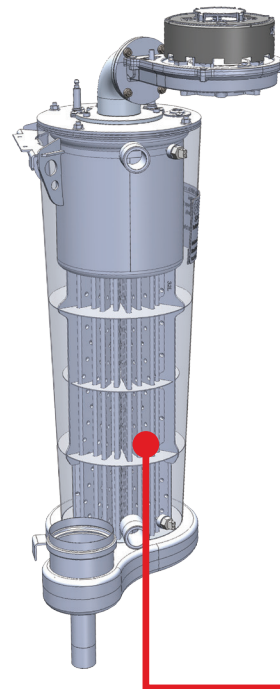

up to **97% Efficient**
up to **5:1 Turndown Ratio**



One of a kind design from the inside, out!

A Closer Look

EFT-155, EFT-285 & EFT-399 Models

(Top connections not available for EFT-55, EFT-80 & EFT-110 models)

Alternate Top Return

Alternate Top Supply

Modulating Combustion Blower Assembly

Sealed Electronic Enclosure (Moisture & Corrosion Resistant)

2 Line 40 Character LCD Display - Program & Monitor Boiler Operation



Alternate Bottom Return

Alternate Bottom Supply

Exhaust Vent Connection

Intake Vent Connection

Easily Removable Cover

Spark Ignition System with Flame Monitoring

Stainless Steel Fire Tube Heat Exchanger

Integrated Digital Control

Field Connection Board

Negative Regulation Gas Valve

Condensate System

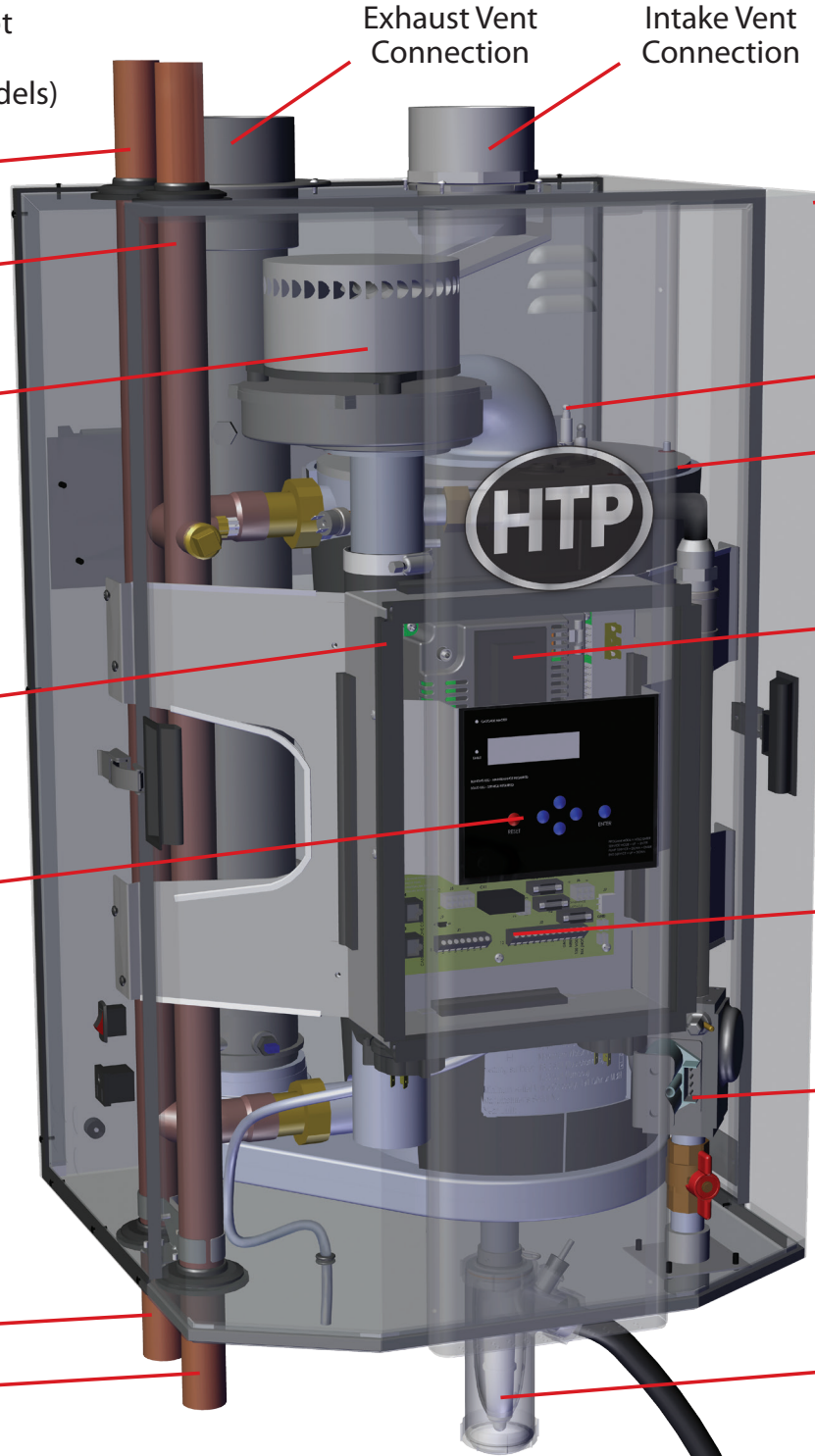

Extremely Durable and Reliable – Minimal Maintenance Required

Energy Savings

Up to **96.8%** AFUE
operating efficiency

Outdoor reset lowers operating
set point automatically to
increase system efficiency

Modulating burner input matches
system load, conserving energy
and increasing system efficiency

Low NOx emission - Reduces
environmental impact

Unbeatable combined vent length
of up to 200 ft 3" PVC pipe
(4" PVC pipe for EFT-399)

Room air intake

Balanced or unbalanced
venting system

Commercial Installation

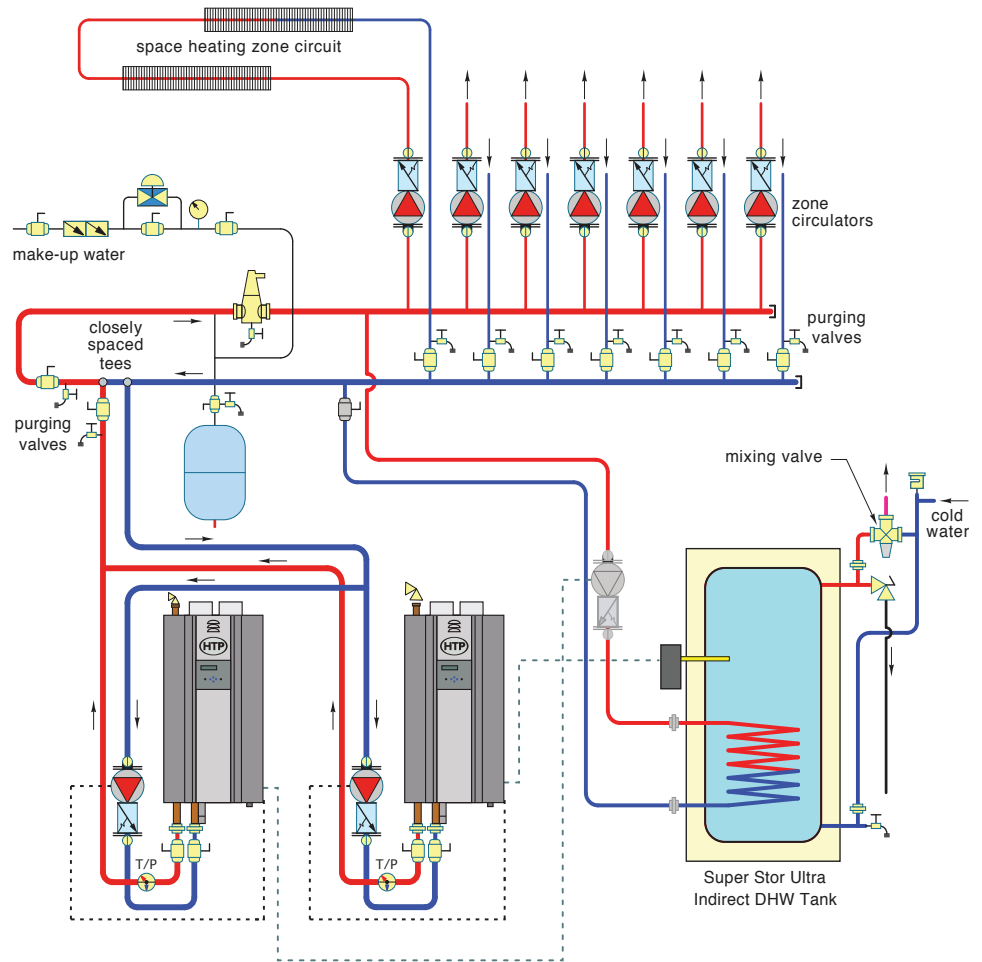

Stainless Steel Fire Tube Heat Exchanger

Down fire design, promotes self
cleaning of combustion system

Durable high grade stainless steel
construction provides extended service life

Increased thermal mass provides low
pressure drop and eliminates short cycling

Compatible with glycol based systems

Built-in condensate collection system

up to 10:1 turndown Ratio

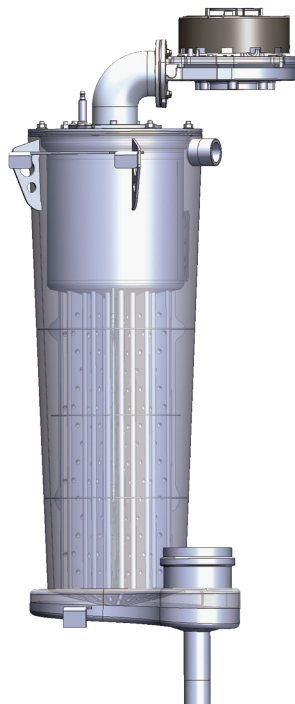

Versatility

Top and Bottom piping connections
(available only for models EFT-155,
EFT-285 & EFT-399)

Field convertible from Natural to LP gas

Wall hung for space savings

No primary / secondary piping required
on models EFT-55, EFT-80 & EFT-110
(minimum flow must be met)

Cascade up to 8 boilers - linked and
sequenced to function together for
commercial installations

Dimensions and Specifications

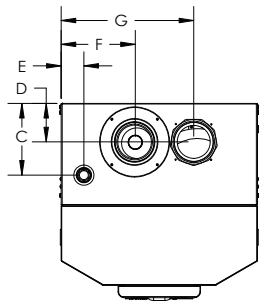

**Models: EFT-55,
EFT-80, EFT-110**

Top View

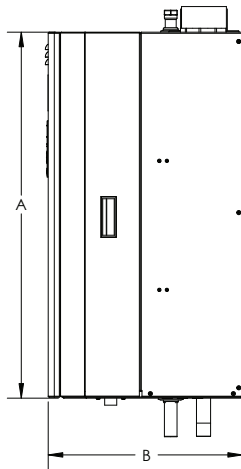

Side View

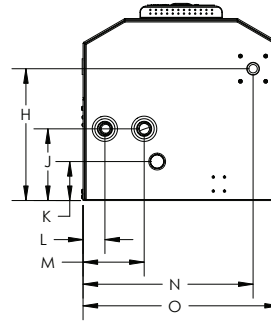

Bottom View

STANDARD FEATURES

- Up to 96.8% AFUE
- Modulating Burner
 - 5:1 Turndown ratio (55-155 Models)
 - 10:1 Turndown ratio (285 & 399 Models)
- Venting Options
 - Concentric
 - 3" Pipe: Balanced or Unbalanced
- Limited 12 Year Warranty
- Wall Mounted
- Total System Control
- The Elite FT is ASME Certified

INCLUDED IN THE BOX

- Temperature and Pressure Gauge
- Pressure Relief Valve 30 PSI (80 psi for EFT-285 & EFT-399 Models)
- Indirect Sensor & Outdoor Sensor
- Intake PVC w/ Screens
- Exhaust PVC Coupling w/ Screens
- Installation Manual
- Warranty
- Condensation Removal System
- Wall Mount

Model	Max. MBH	Min. MBH	AFUE	Heating Capacity MBH	A	B	C	D	E	F	G	H	J	K	L	M	N	O
EFT-55	55	13	96.8	51	32 1/2"	17 3/8"	6 1/4"	3 1/2"	2 1/4"	6 1/2"	11 3/4"	12 1/2"	6 1/4"	3 1/2"	2"	5 1/2"	15"	17 1/2"
EFT-80	80	17	96	79														
EFT-110	110	22	95.6	102														

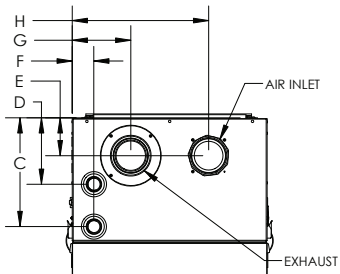

**Models: EFT-155,
EFT-285 & EFT-399**

Top View

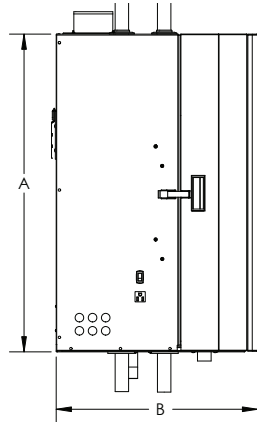

Side View

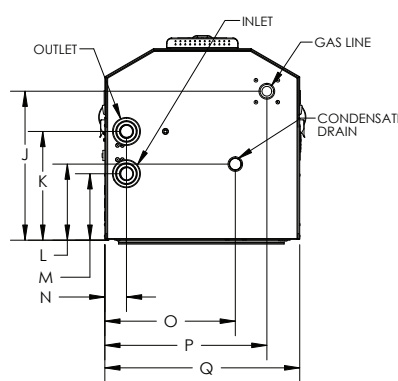

Bottom View

OPTIONAL EQUIPMENT

- ModBus Adapter
- 3", 4", 6" Stainless Steel Outside Termination Vent Kit
- 3" Concentric Vent Kit
- 3" Polypro Vent Kit
- 3" Polypro Pipe
- U.L. 353 Compliant Low Water Cutoff w/ Manual Reset
- Alarm System to Monitor Failures
- PC Connection Kit
- Condensate Neutralizer
- System Sensor
- 3 Speed Pump with integrated Flow Check
- LP Conversion Kit

Model	Max. MBH	Min. MBH	AFUE	Net Ratings (water)	Heating Capacity MBH	A	B	C	D	E	F	G	H	J	K	L	M	N	O	P	Q
EFT-155	155	31	95.5	-	142	32 5/8"	20 5/8"	11 1/8"	6 7/8"	3 7/8"	2 1/4"	6"	14"	15 1/4"	11 1/8"	7 3/4"	6 7/8"	2 1/4"	13 3/8"	16 5/8"	20"
EFT-285	285	28.5	95.1	-	262																
EFT-399	399	39.9	97.1*	323 Mbh	367																

* Thermal Efficiency (Not AFUE)

Model	Btuh	Turndown	Shipping Weight	Gas Conn.	Water Conn.	Air Inlet	Vent Size
EFT-55**	55,000	5:1	125 lbs.	3/4"	1"	3"	3"
EFT-80**	80,000	5:1	128 lbs.				
EFT-110**	110,000	5:1	130 lbs.				
EFT-155**	155,000	5:1	195 lbs.		1 1/4"		
EFT-285**	285,000	10:1	203 lbs.				
EFT-399**	399,000	10:1	298 lbs.			1 1/2"	4"

** add PU to end of stock code to include a pump

